

**CHERRY**  
COLLECTION

LET  
THE  
STORY  
BEGIN!

CHERRYNOTE.COM

All rights reserved  
Distributed in U.S.A.  
& abroad by:  
SAB America Inc.  
[www.sabamerica.net](http://www.sabamerica.net)

Cherrynote®  
SAB America Inc.  
MI 48126, U.S.A.  
[info@cherrynote.com](mailto:info@cherrynote.com)  
[www.cherrynote.com](http://www.cherrynote.com)



The paper used in our notebooks is FSC certified, environmental friendly and from well-managed sustainable sources to protect world's forests.

The leather used in our notebooks is certified and tested as completely not hazardous for human health.

# INTRO DUCTION

Cherrynote® is the result of public demand for fashion, high quality and classy notebooks. The brand is demonstrated as a unique, creative and luxurious brainstorming and note-saving tool. Cherrynote® brings back to life the sense of fashion and artistic tradition by creating extraordinary designs with a perfected finish.

The brand diversifies from corporate to retail sectors and its collections are known as open platforms for creativity. The cherrynote® corporate collection can be customized to transmit corporate messages at many levels. This includes digital messages as invented in the cherrynote® collection which was created by the cherrynote® brand holder, SAB America, Inc.

Cherrynote's retail collection is designed to suit each and every person's taste. This was successfully created through our expertise in design and production techniques.

Cherrytech is part of the corporate and retail collection that combines technology with notebooks by integrating a built-in LCD screen to convey or display messages and commercial ads of companies, entities and to end users.

Refining notebooks' quality and providing customers worldwide with cherrynote® notebooks signals out the brand as a notebook with a cherry on top.

# YOUNG & DARING IN ITS STYLE

The brand is new, fresh, yet elegant and luxurious with a twist. Targeting many sectors of society, each collection is speaking the language of its target audience. Girls, boys, young and old, no matter the age or the style, there is always a notebook style that suits various tastes and tendencies.

## CONTENTS

- 06** CHERRY TECH
- 10** CHERRY PLADA
- 12** CHERRY TOTEM
- 14** CHERRY MILLENIA
- 16** CHERRY TYPOGRAFIA
- 18** CHERRY ADVENTURE
- 20** CHERRY FASHION
- 22** CHERRY CROQUIS
- 24** CHERRY LANDMARK
- 26** CHERRY MONOTONE
- 30** CHERRY INSIDE

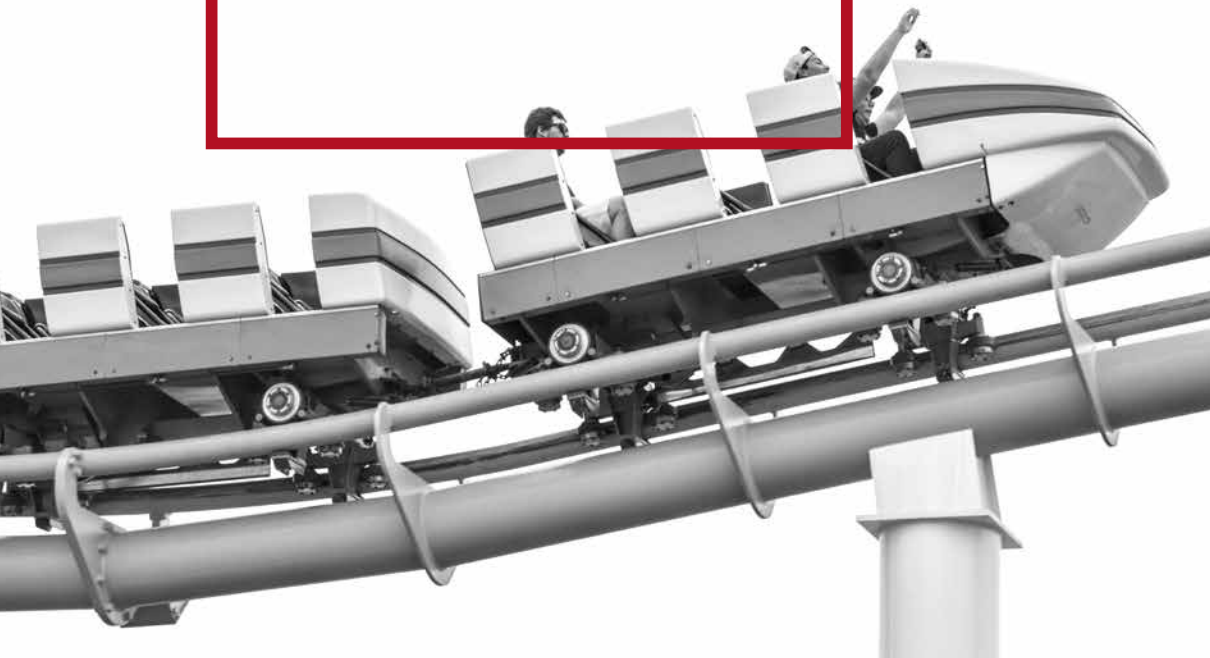

# 05



NEW PRODUCT

## WHEN TECH MEETS CHERRY

A NOTEBOOK WILL  
MAKE WONDERS



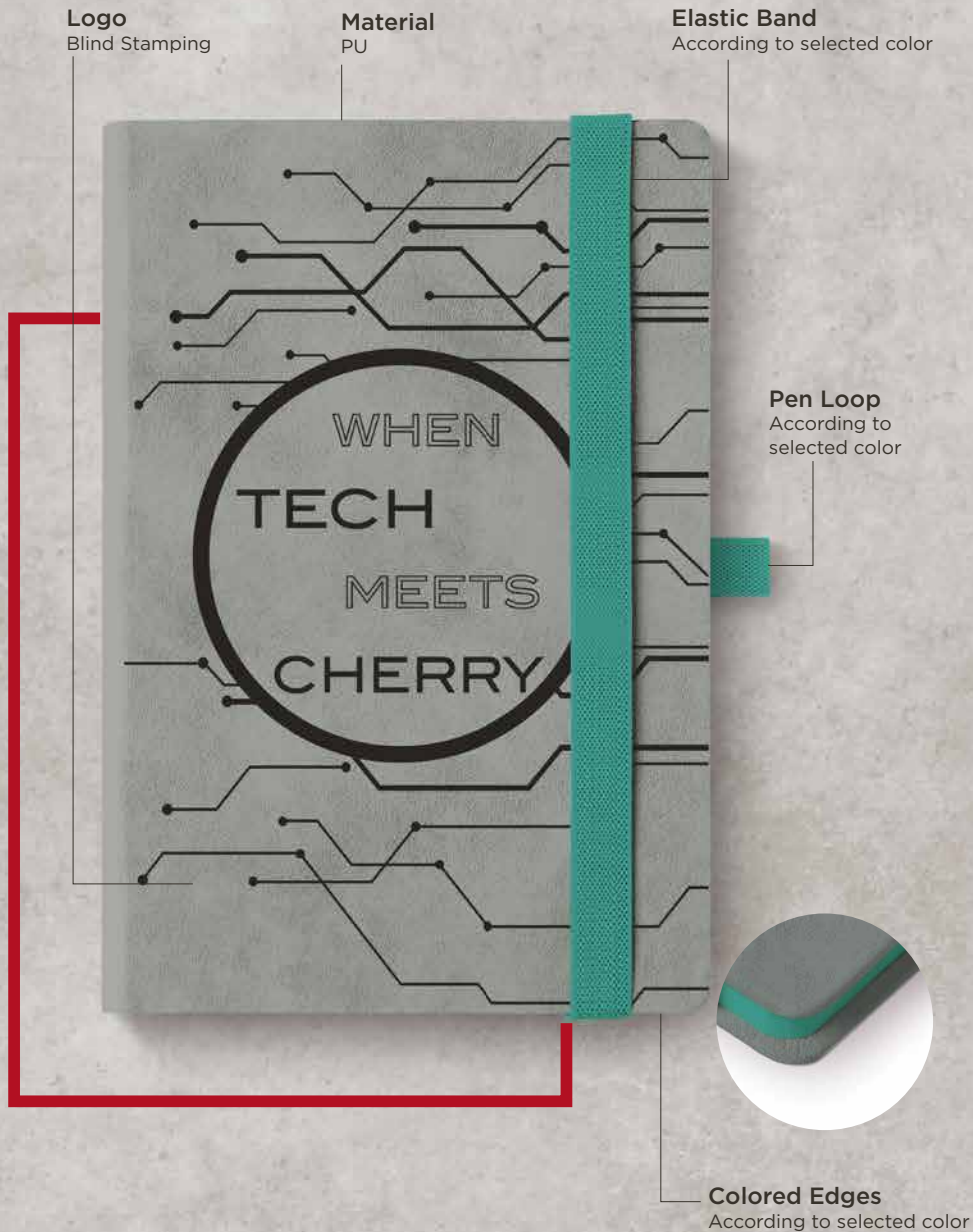

Cherry Tech Sample

# CHERRY TECH

## Cover

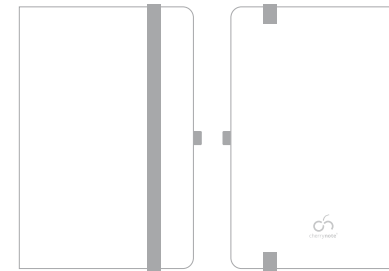

Front Cover

Back Cover

## Inside Cover

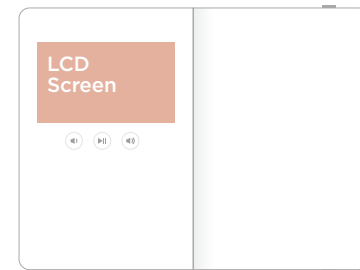

Page 1

Page 2

## Size

### A5

210 x 140 mm  
8.2 x 5.5 in

### B5

165 x 235 mm  
6.4 x 9.2 in

## Material

PU  
Printable PU  
Genuine Leather

## Stamping

Blind Stamping  
Foil Stamping

## Add-ons

Elastic Band  
Pen Loop  
Colored Edges  
Paper Pocket

## Collection Colors



## Paper

192 pages  
80 gsm

## Paper Colors



## Layout

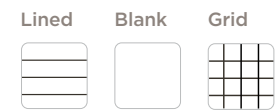

## Prices

### A6

PU

### A5

PU

# 09



CHERRYNOTE.COM

## SHOW YOUR TRUE COLORS

A PICTURE IS WORTH  
A THOUSAND WORDS



Material  
PU

Elastic Band

Pen Loop

Colored Edges

# CHERRY PLADA

## Plada Collection



Original

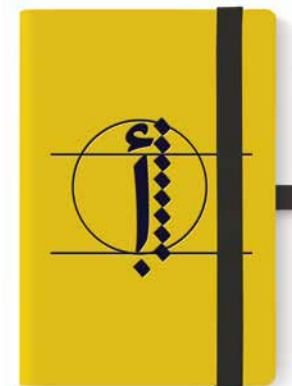

Alphabet

## Size

### A6

95 x 140 mm  
3.7 x 5.5 in

### A5

210 x 140 mm  
8.2 x 5.5 in

### B5

165 x 235 mm  
6.4 x 9.2 in

## Material

PU

## Stamping

Foil Stamping

## Add-ons

Elastic Band  
Pen Loop  
Colored Edges  
Paper Pocket

## Collection Colors



## Paper

192 pages  
80 gsm

## Paper Colors



## Layout

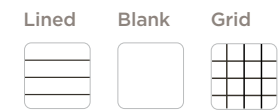

## Prices

### A6

PU

### A5

PU

### B5

PU



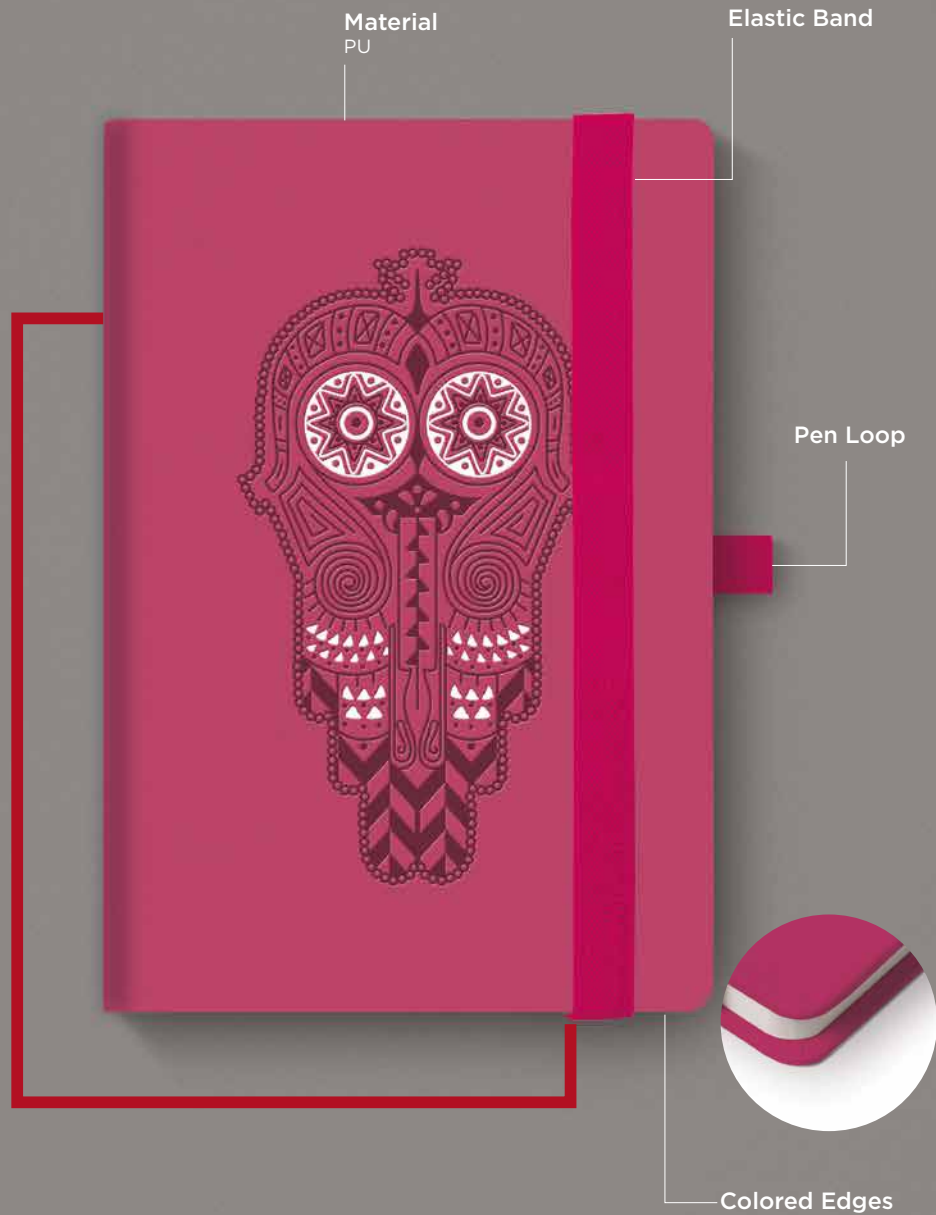

Owl

# CHERRY TOTEM

## Totem Collection



Elephant



Cactus

### Size

**A6**

95 x 140 mm  
3.7 x 5.5 in

**A5**

210 x 140 mm  
8.2 x 5.5 in

**B5**

165 x 235 mm  
6.4 x 9.2 in

### Material

PU

### Stamping

Foil Stamping

### Add-ons

Elastic Band  
Pen Loop  
Colored Edges  
Paper Pocket

### Collection Colors



### Paper

192 pages  
80 gsm

### Paper Colors



### Layout

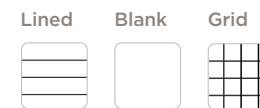

### Prices

**A6**

PU

**A5**

PU

**B5**

PU





 Skeleton

# CHERRY MILLENIA

## Millenia Collection

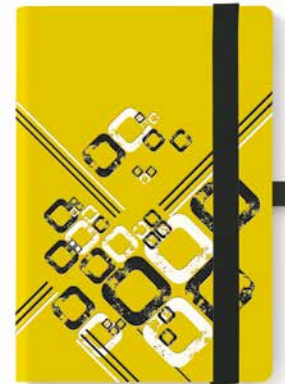

Objects



Butterfly

### Size

**A6**

95 x 140 mm  
3.7 x 5.5 in

**A5**

210 x 140 mm  
8.2 x 5.5 in

**B5**

165 x 235 mm  
6.4 x 9.2 in

### Material

PU

### Stamping

Foil Stamping

### Add-ons

Elastic Band  
Pen Loop  
Colored Edges  
Paper Pocket

### Collection Colors



### Paper

192 pages  
80 gsm

### Paper Colors



### Layout

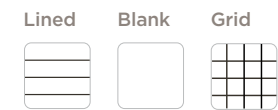

### Prices

**A6**

PU

**A5**

PU

**B5**

PU

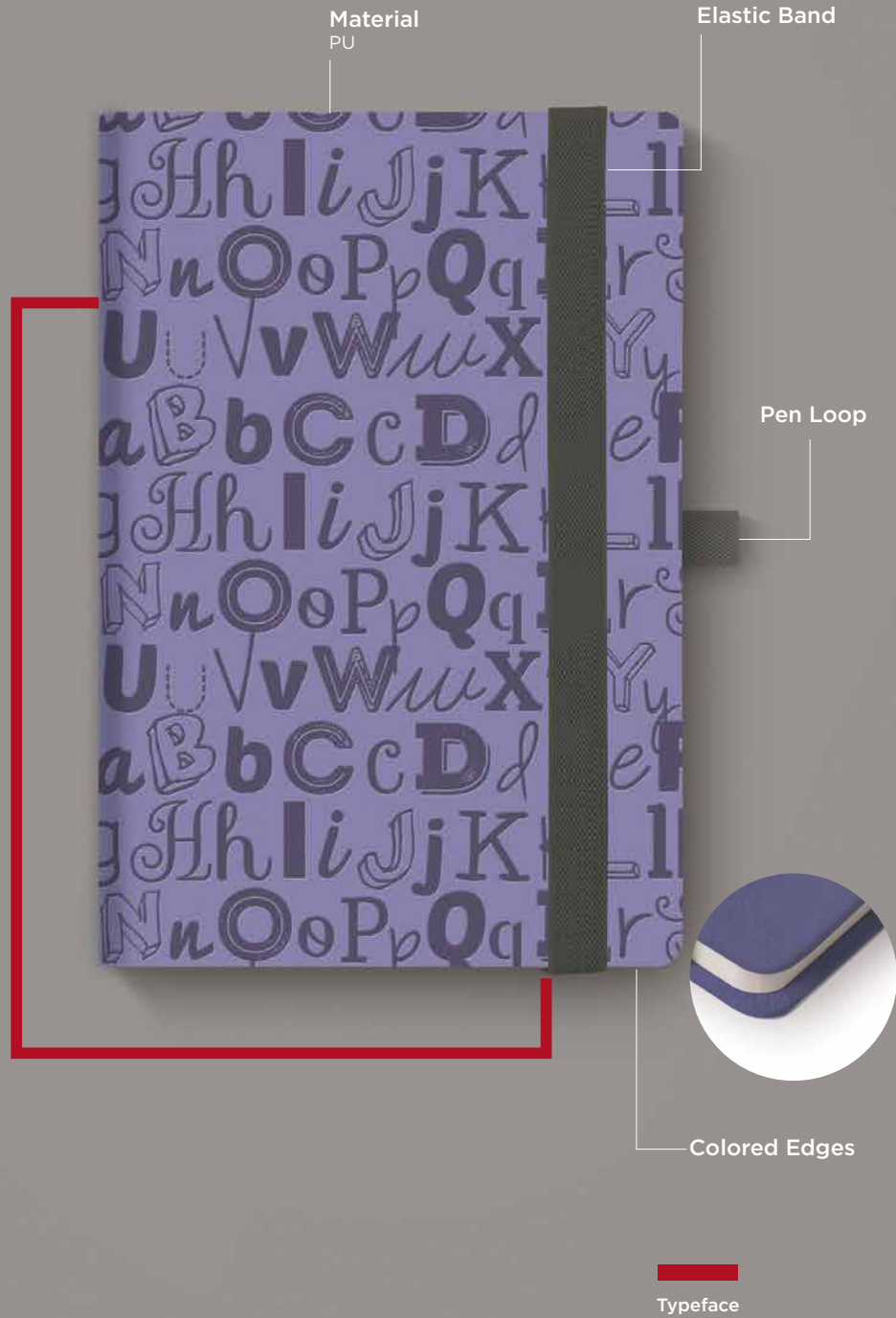

# CHERRY TYPOGRAFIA

## Typografia Collection



Phonograph



Rebel



Waw

### Size

**A6**

95 x 140 mm  
3.7 x 5.5 in

**A5**

210 x 140 mm  
8.2 x 5.5 in

**B5**

165 x 235 mm  
6.4 x 9.2 in

### Material

PU

### Stamping

Foil Stamping

### Add-ons

Elastic Band  
Pen Loop  
Colored Edges  
Paper Pocket

### Collection Colors



### Paper

192 pages  
80 gsm

### Paper Colors



### Layout

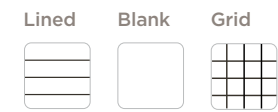

### Prices

**A6**

PU

**A5**

PU

**B5**

PU



# CHERRY ADVENTURE

## Adventure Collection



Umbrellas



Pattern

### Size

**A6**

95 x 140 mm  
3.7 x 5.5 in

**A5**

210 x 140 mm  
8.2 x 5.5 in

**B5**

165 x 235 mm  
6.4 x 9.2 in

### Material

PU

### Stamping

Blind Stamping

### Add-ons

Elastic Band  
Pen Loop  
Colored Edges  
Paper Pocket

### Collection Colors



### Paper

192 pages  
80 gsm

### Paper Colors



### Layout

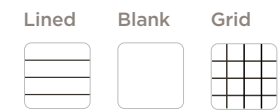

### Prices

**A6**

PU

**A5**

PU

**B5**

PU



# CHERRY FASHION

## Fashion Collection



Wings



Lace

## Size

### A6

95 x 140 mm  
3.7 x 5.5 in

### A5

210 x 140 mm  
8.2 x 5.5 in

### B5

165 x 235 mm  
6.4 x 9.2 in

## Material

PU

## Stamping

Blind Stamping  
Foil Stamping

## Add-ons

Elastic Band  
Pen Loop  
Colored Edges  
Paper Pocket

## Collection Colors



## Paper

192 pages  
80 gsm

## Paper Colors



## Layout



## Prices

### A6

PU

### A5

PU

### B5

PU



**Material**  
Printable PU

**Elastic Band**

**Pen Loop**

**Colored Edges**

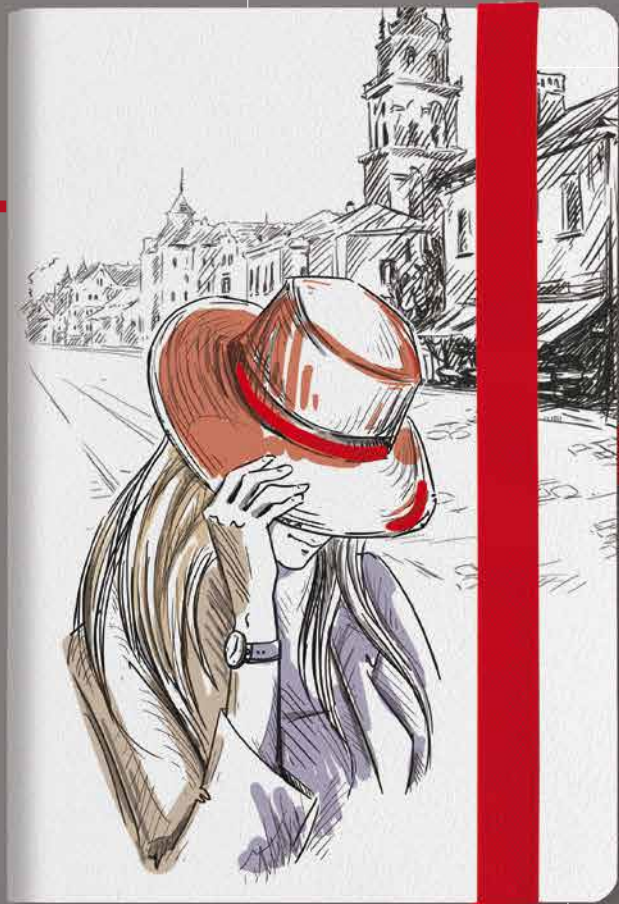

Woman

# CHERRY CROQUIS

## Croquis Collection



Trendy



City Walk 1

### Size

**A6**  
95 x 140 mm  
3.7 x 5.5 in

**A5**  
210 x 140 mm  
8.2 x 5.5 in

**B5**  
165 x 235 mm  
6.4 x 9.2 in

### Material

Printable PU

### Stamping

Blind Stamping  
Foil Stamping  
Full Color  
Printing

### Add-ons

Elastic Band  
Pen Loop  
Colored Edges  
Paper Pocket

### Collection Colors



### Paper

192 pages  
80 gsm

### Paper Colors



### Layout

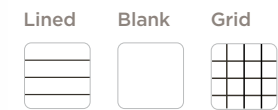

### Prices

**A6**  
Printable PU

**A5**  
Printable PU

**B5**  
Printable PU



  
U.S. Flag

# CHERRY LANDMARK

## Landmark Collection



Broadway



City Walk 2



Subway

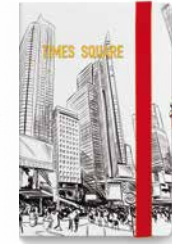

Times Square



U.S. Foundation

## Size

**A6**  
95 x 140 mm  
3.7 x 5.5 in

**A5**  
210 x 140 mm  
8.2 x 5.5 in

**B5**  
165 x 235 mm  
6.4 x 9.2 in

## Material

Printable PU

## Stamping

Blind Stamping  
Foil Stamping  
Full Color  
Printing

## Add-ons

Elastic Band  
Pen Loop  
Colored Edges  
Paper Pocket

## Collection Colors

W01 **B03**

## Paper

192 pages  
80 gsm

## Paper Colors

White **Ivory** Cream

## Layout

Lined **Blank** Grid

## Prices

**A6**  
Printable PU

**A5**  
Printable PU

**B5**  
Printable PU

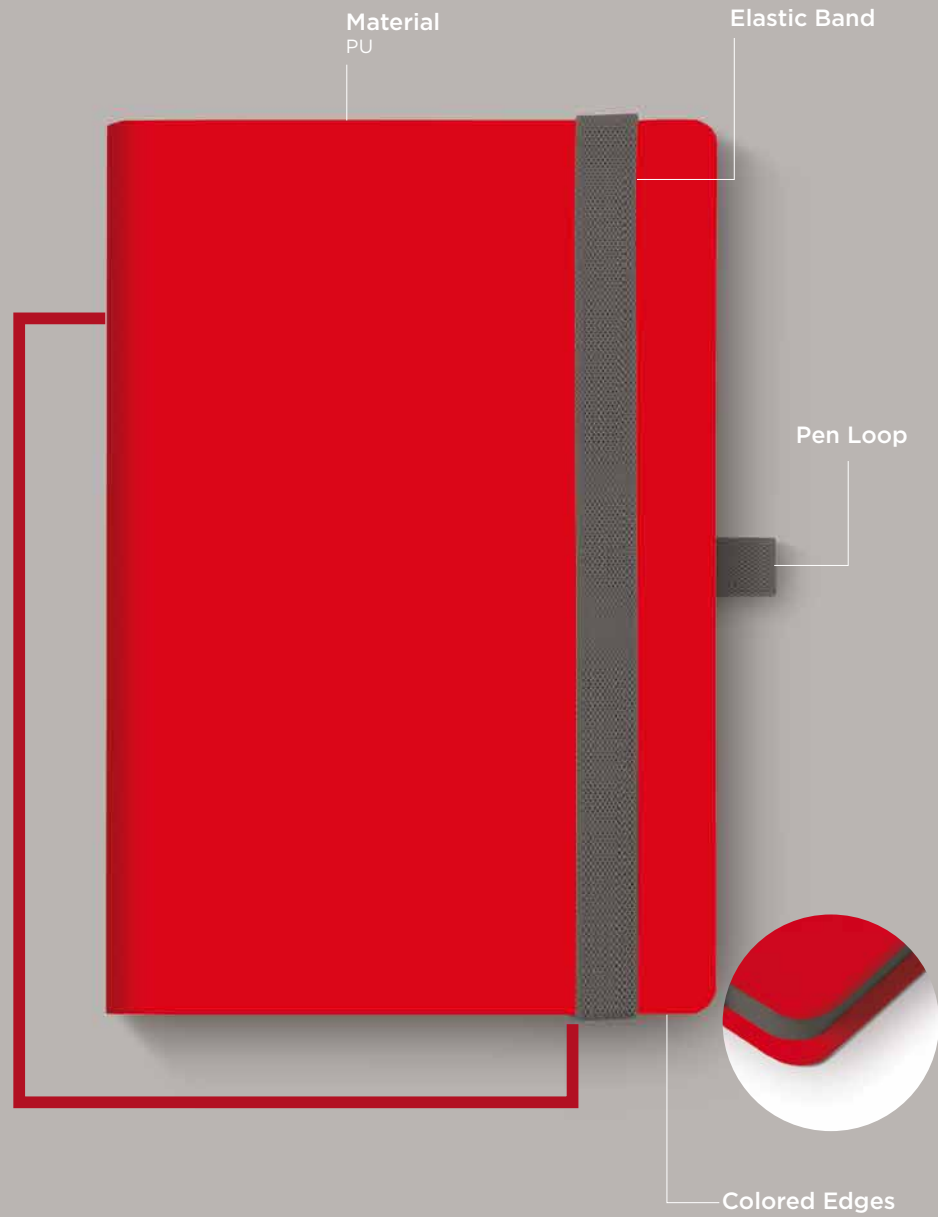

  
Monotone

# CHERRY MONOTONE

## Size

### A6

95 x 140 mm  
3.7 x 5.5 in

### A5

210 x 140 mm  
8.2 x 5.5 in

### B5

165 x 235 mm  
6.4 x 9.2 in

## Material

PU

## Stamping

Blind Stamping  
Foil Stamping

## Add-ons

Elastic Band  
Pen Loop  
Colored Edges  
Paper Pocket

## Collection Colors



## Paper

192 pages  
80 gsm

## Paper Colors



## Layout

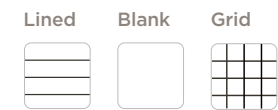

## Prices

### A6

PU

### A5

PU

### B5

PU

# 29



CHERRYNOTE.COM

## THINK INSIDE THE BOX

BECAUSE YOU  
CAN NOT TELL A  
BOOK BY ITS COVER



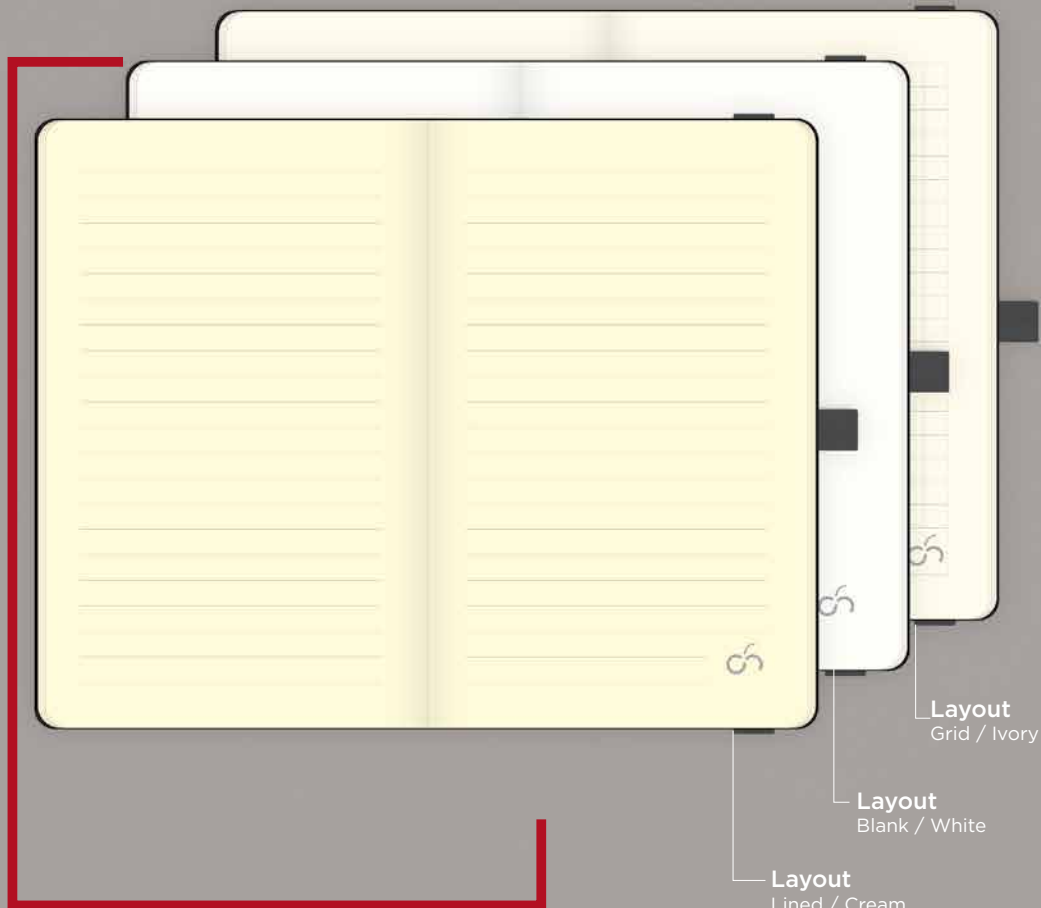

Layouts' Samples

# CHERRY INSIDE

## Inside Cover

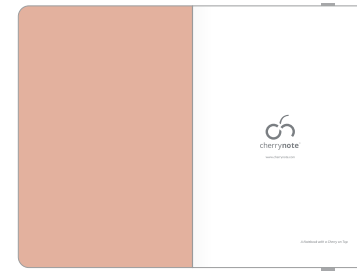

Page 1

Page 2

## Paper

192 pages  
80 gsm

## Paper Colors



## Layout

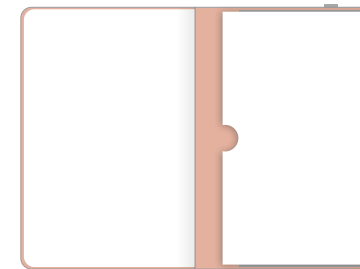
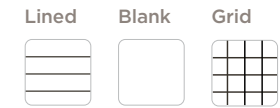

End Page

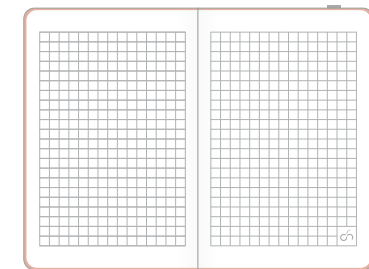

Grid



Blank

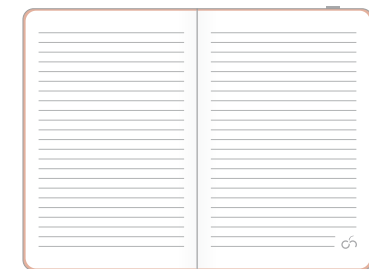

Lined

## SAB America Inc.

### U.S.A. & abroad Distributors

SAB America Inc.  
T +1 313 334 3380  
Toll Free +1 844 245 6070  
F +1 313 922 5122  
MI 48126, U.S.A.  
info@sabamerica.net

### ME Distributors

SAB International  
T/F +961 5 953 553  
Beirut, Lebanon  
cherrynote@sab.com.lb

### Cherrynote®

SAB America Inc.  
MI 48126, U.S.A.  
info@cherrynote.com



---

[www.sabamerica.net](http://www.sabamerica.net)

---

[www.sab.com.lb](http://www.sab.com.lb)

---

[www.cherrynote.com](http://www.cherrynote.com)



EVERY  
NEW  
CHALL-  
ENGE  
A NEW  
JOURNEY

BE READY

**Material:**

SAB Team

**Printing:**

Commitment Ink

**Elastic Band:**

Team Spirit

**Finishing:**

Experience &

meticulousness